

RoHS

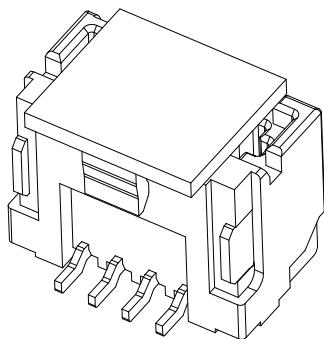
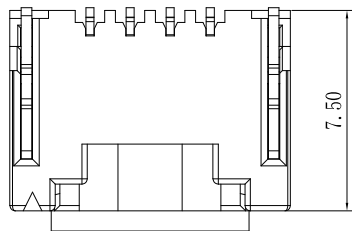

SPECIFICATION

- Voltage rating: 100V AC, DC
- Current Rating: 2A, AC, DC
- Withstand voltage: 500V AC/minute
- Contact resistance: 40mΩ max
- Insulation resistance: 500MΩ min
- Temperature range: -40° C ~ +105° C

WAFER

- Material: PA9T UL94V-0
- Contact area, Brass Tin-plated
- Pin: Phosphor Bronze
- Suitable JVT1504H series Terminal
- JVT1504W series Wafer



JVT1504W9T-XXSNC-S
 Logo Series NO. Wafer PA9T SMT Cap Tin Plated Pin NO.

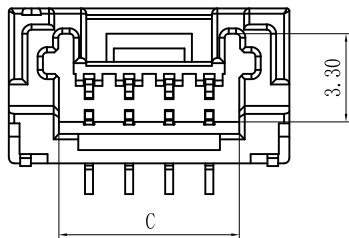
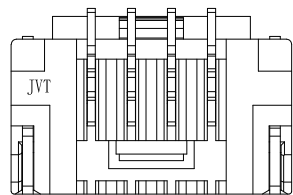
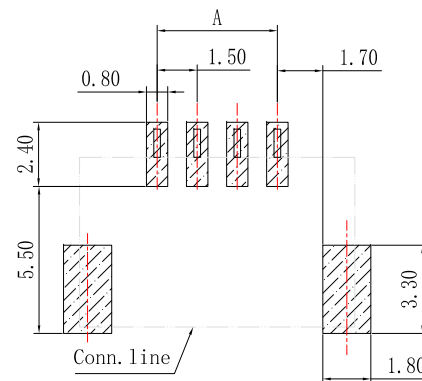
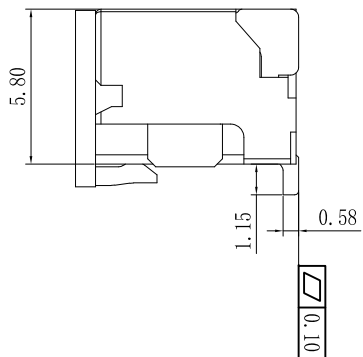
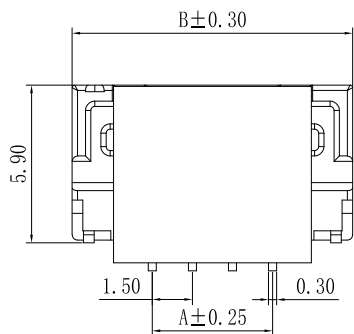

Recommended P.C.B Layout
 General Tolerance ±0.05

CKL	DimA	DimB	DimC
02	1.5	7.50	3.75
03	3.0	9.00	5.25
04	4.5	10.50	6.75
05	6.0	12.00	8.25
06	7.5	13.50	9.75
07	9.0	15.00	11.25
08	10.5	16.50	12.75
09	12.0	18.00	14.25
10	13.5	19.50	15.75
11	15.0	21.00	17.25
12	16.5	22.50	18.75
13	18.0	24.00	20.25
14	19.5	25.50	21.75
15	21.0	27.00	23.25
16	22.5	28.50	24.75

				JVT 乔业连接器 JVT CONNECTORS				Approved by	Check	Design	Standard	1.5mm Vertical WAFER SMT Cap		
				CONNECTORS				LI	CLYDE	LU	P/N	JVT1504W9T-XXSNC-S		
Version	Content of change	Date	Signature	Unit	mm	Scale	1:1	Date	20200629	Map title	031	Version	A0	